

Job:

Item:

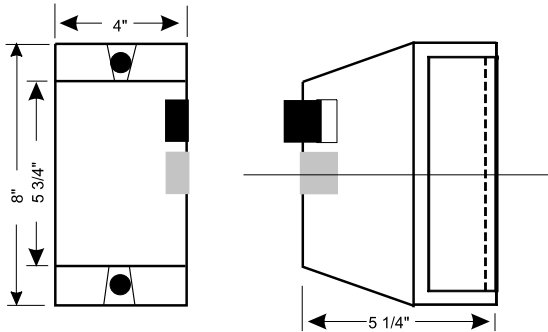

### Hammerall Model CA 45x

Composite

**Specifications:**

Non-metallic IP-65 Gasketed Enclosure  
(Suitable for wash-down)  
Magnetic Contactors

**Voltages Available:**

 1 Phase - 115 Volt, 230 Volt • 3 Phase - 208-230 Volt, 460 Volt

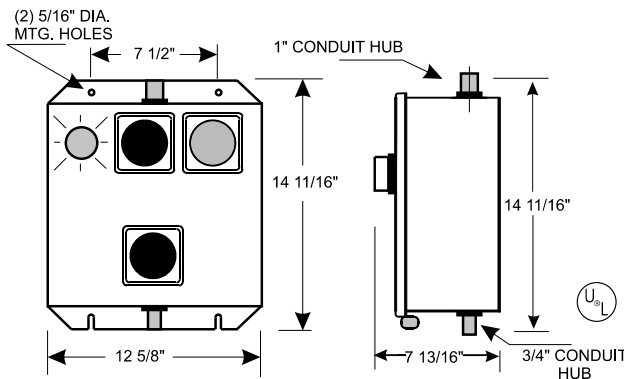

### Hammerall Model CA 50SS

Stainless Steel

### Hammerall Model CA 50SS-P

Stainless Steel

**Specifications:**

NEMA Type 4 Water-tight Stainless Steel Enclosure  
Magnetic Contactors  
Pilot Light - On (Hammerall Model CA50SS-P)

**Voltages Available:**

 1 Phase - 115 Volt, 230 Volt • 3 Phase - 208-230 Volt, 460 Volt

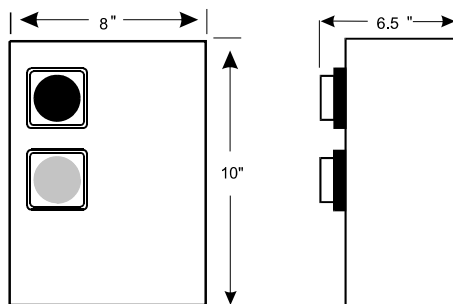

### Hammerall Model CA 55SS

Stainless Steel

**Specifications:**

NEMA 4x Enclosure  
Magnetic Contactors

Start/Stop Push Buttons  
Delay Timer

**Voltages Available:**

 1 Phase - 115 Volt, 230 Volt • 3 Phase - 208-230 Volt, 460 Volt

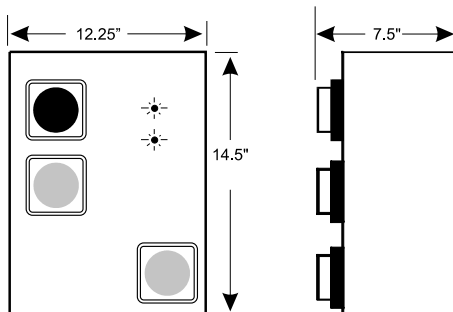

### Hammerall Model CA 60SS

Stainless Steel

**Specifications:**

NEMA 4x Enclosure  
Magnetic Contactors  
Disconnect Switch  
Start/Stop Push Buttons

Illuminated Push Buttons  
Positive Flush Pilot Light  
Motor Overload Pilot Light  
Delay Timer

**Voltages Available:**

 1 Phase - 115 Volt, 230 Volt • 3 Phase - 208-230 Volt, 460 Volt